

# WENEBRIK

BRITISH MADE

In this book of instructions there are illustrations of 70 different models that can be built with Wenebrik. You will find it extremely fascinating designing a new model, as hundreds more may be built. Wenebrik is the most popular building toy for girls. There are no tools, no small parts to lose, and nothing to puzzle the youngest child.



**This is a street  
in a WENEBRIK village**

Wenebrik models are real buildings in miniature, embodying correct scale construction with perfect colour effects. Each outfit contains a number of Bricks, Ridge Tiles, Slates, Cornice Doors and Frames. (Chimneys and Gutters are included in the larger outfits).

SOLE MANUFACTURERS: WILLIAM BAILEY (BIRMINGHAM), LTD., BIRMINGHAM, ENGLAND



(PRONOUNCED AS "WEENY BRICK.")

The No. 0 set of Wenebrik will build the first ten models shown in this manual, the No. 1 the first thirty, the No. 2 the first forty, the No. 3 the first fifty, the No. 4 the first sixty, and the No. 5 will build all of the seventy; and in addition, each set can be used to make miniatures of other buildings not shown in the manual. The units in every set are the same, and two sets can be used together for building larger models. To complete the appearance of the houses, small pieces of lace can be fixed inside the windows.

## INSTRUCTIONS.

Before beginning to build a model, thoroughly examine the list of the Wenebrik parts on pages 3 and 4: you will then be able to select the pieces required for each model. Then carefully study the drawings on pages 5 and 6, which will make quite plain the right way to build.

Drawing A shows how the tongues of the bricks fit into the grooves of the bases, and how the tongues of the second row of bricks fit into the grooves of the first row. Drawings B and E are marked with the numbers of the pieces used, and show how the parts all fit nicely together and also make quite clear how to fix the windows and doors.

Always endeavour to make each brick fit half over each of the two below and then the one above will keep the two below in place.

Drawing D shows how to make the roof and Drawing C how to make the cornice pieces keep in place, on which the roof rests.

# WENEBRIK

BRITISH MADE

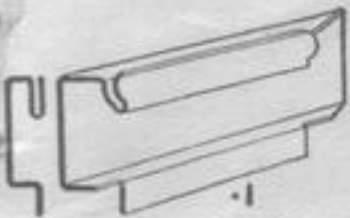

1  
BRICK

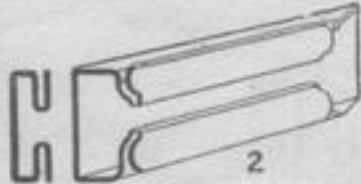

2  
FOUNDATION  
BRICK



3  
SQUARE CORNER  
BRICK



4  
INVERTED SQUARE  
CORNER BRICK



5  
HEXAGON CORNER  
BRICK

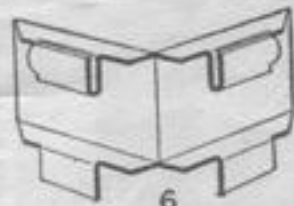

6  
INVERTED HEXAGON  
CORNER BRICK



7  
FOUNDATION CORNER  
BRICK



8  
HALF  
BRICK



9  
SLATE



10  
HALF SLATE

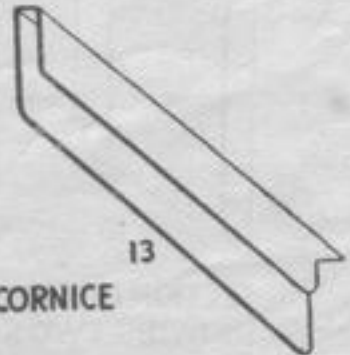

13  
CORNICIE



11  
GUTTER



12  
HALF GUTTER



14  
RIDGE TILE



15  
END RIDGE TILE

# WENEBRIK

BRITISH MADE



16  
WINDOW  
1½ X 1½

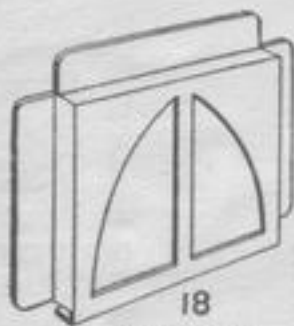

18  
WINDOW  
1½ X 1

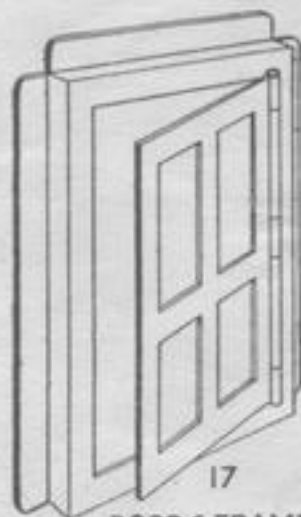

17  
DOOR & FRAME

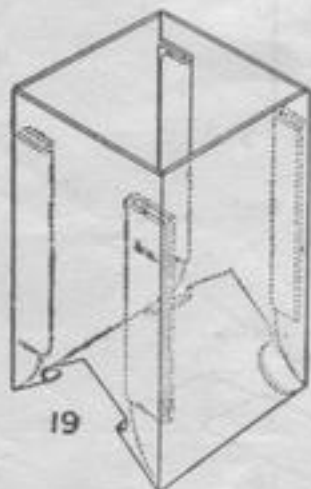
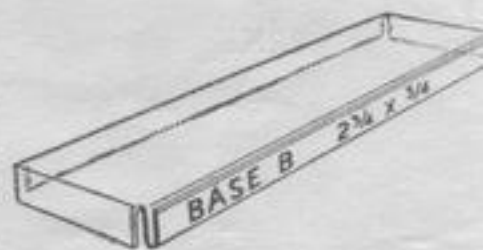

19  
CHIMNEY

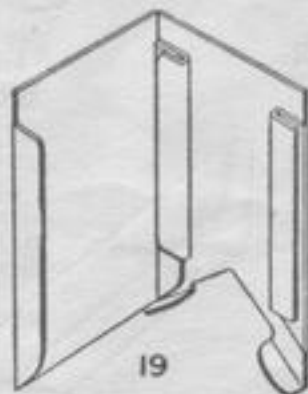

19  
SECTION OF CHIMNEY  
SHOWING TWO SIDES

**BASES**

A	—	6½"	x	½"
B	—	2¾"	x	¾"
C	—	7¼"	x	1"
D	—	5¾"	x	¾"
E	—	5"	x	½"
F	—	4¼"	x	½"
G	—	9½"	x	1⅞"
H	—	13¼"	x	3⅞"

# WENEBRIK

BRITISH MADE

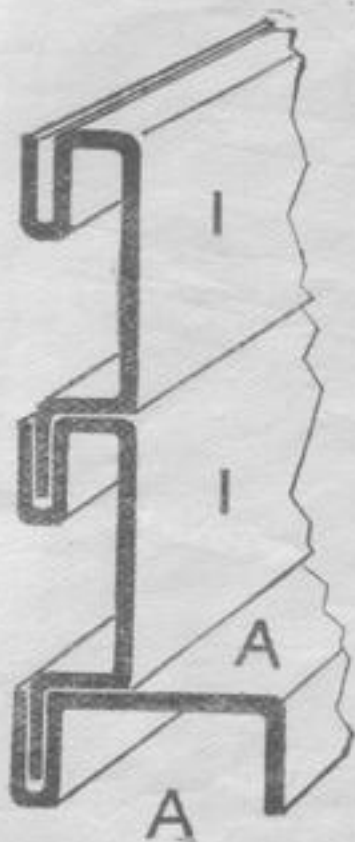

Double size illustration of a section showing the principle of construction.

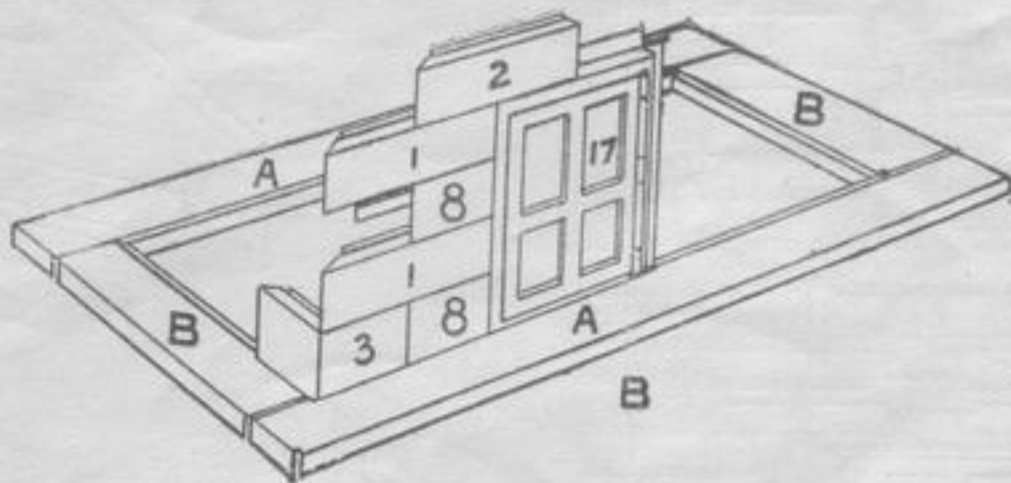
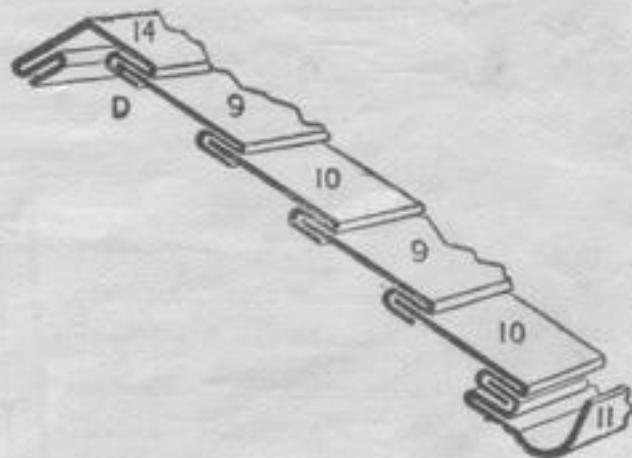

Illustration B shows the foundation on Bases A and B, with other parts in position to continue building.



Section D shows Ridge Tile No. 14, with alternate rows of Slates No. 9, and Half Slates No. 10. Gutter No. 11 is attached to the last row of slates

# WENEBRIK

BRITISH MADE

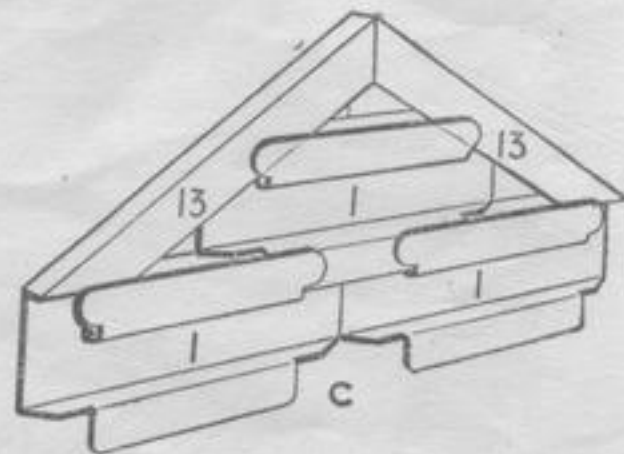
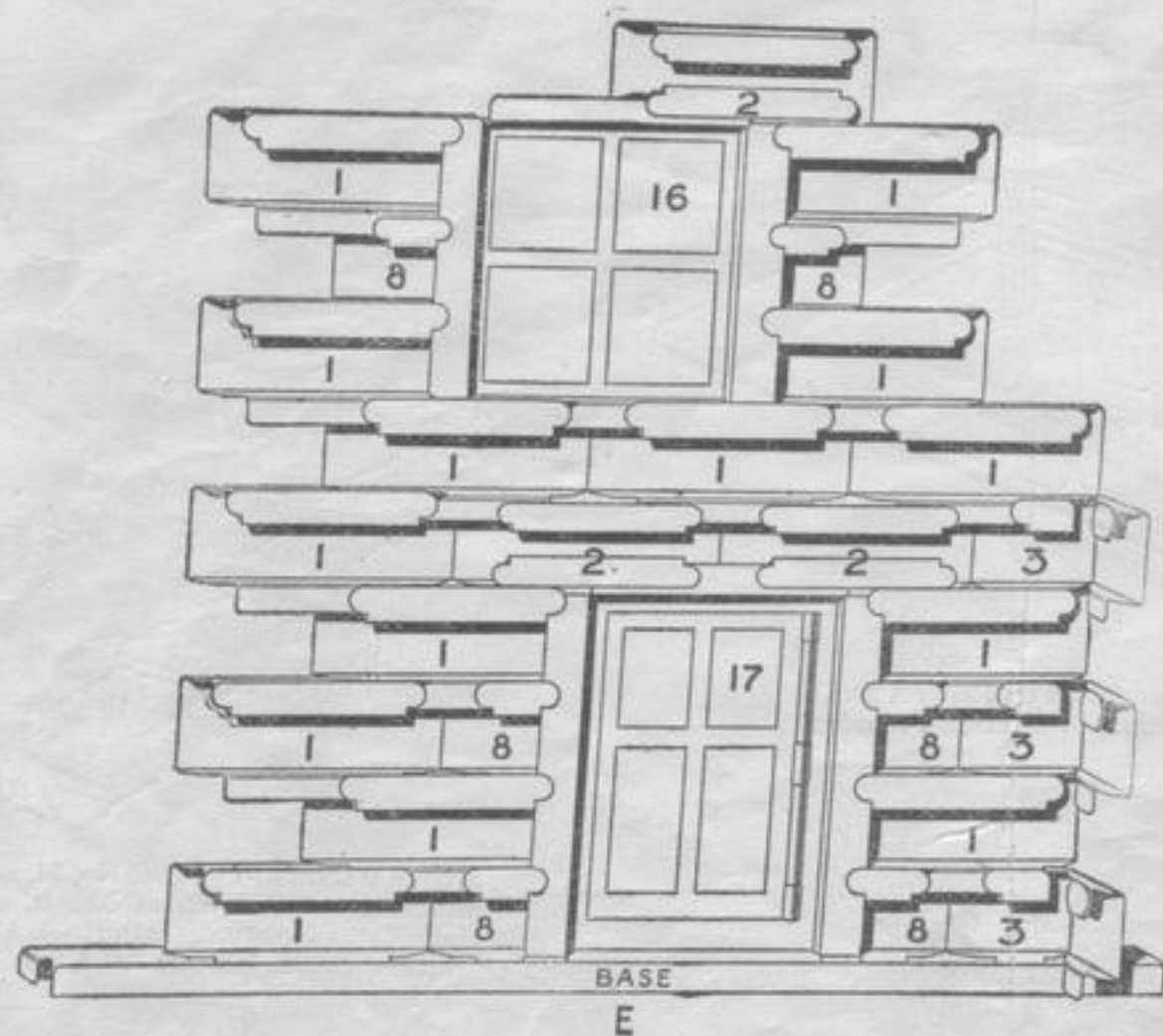

**Elevation C.** Interior of top wall, showing the fixing of the Cornice.

**Illustration E.** Interior of wall, showing the fixing of door No. 17 and window No. 16. It will be seen that the wide flange on each side of door and window is gripped by the lip on inside of bricks. No. 2 Foundation Brick is placed above the door frame and the window

No. 0 Set  
Builds

# WENEBRIK

BRITISH MADE

All Models  
from 1 to 10



Model No. 1



Model No. 2



Model No. 3



Model No. 1



Model No. 2



Model No. 3

Parts required	1	2	3	8	9	10	13	14	15	16	17	Bases.	
												A	B
<b>For Model No. 1</b>	9	10	14	10	40	8	4	5	1	5	1	2	2
<b>2</b>	9	10	14	10	40	8	4	5	1	5	1	2	2
<b>3</b>	9	7	9	8	32	8	4	4	1	3	1	2	2

No. 0 Set  
Builds

# WENEBRIK

BRITISH MADE

All Models  
from 1 to 10



4  
Model No. 4



5  
Model No. 5



6  
Model No. 6



4  
Model No. 4



5  
Model No. 5



6  
Model No. 6

Parts required	1	2	3	8	9	10	13	14	15	16	17	Bases.	
												A	B
<b>For Model No. 4</b>	9	3	9	7	28	8	4	3	1	3	1	2	2
5	7	8	14	2	24	8	4	3	1	3	1	2	2
6	4	8	14	8	24	8	4	3	1	4	1	2	2



No. 0 Set  
Builds

# WENEBRIK

BRITISH MADE

All Models  
from 1 to 10



Model No. 7

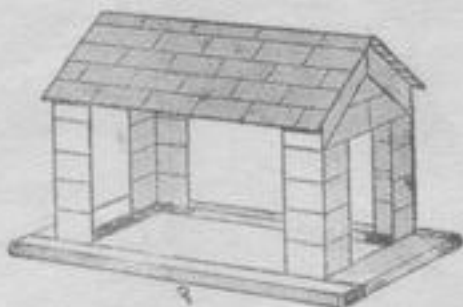

Model No. 8

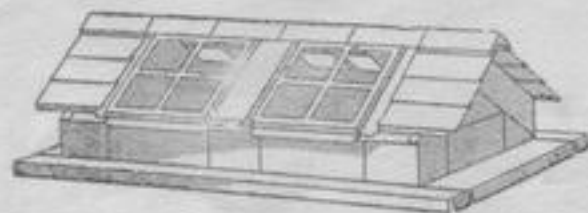

Model No. 9



Model No. 7

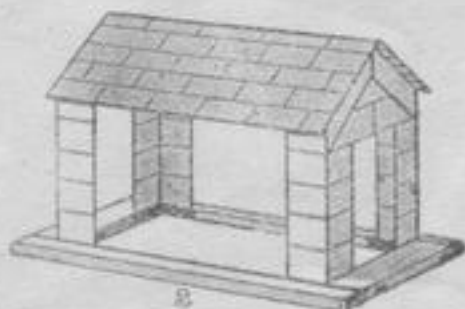

Model No. 8

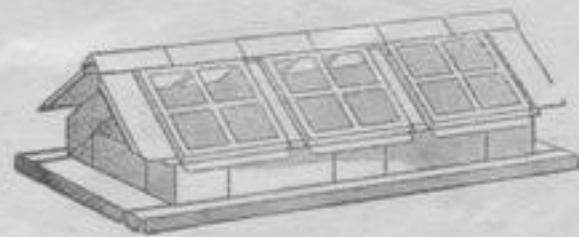

Model No. 9

Parts required	1	2	3	8	9	10	13	14	15	16	Bases.	
											A	B
<b>For Model No. 7</b>	9	7	12	6	40	8	4	5	1	4	2	2
8	6	—	14	8	40	8	4	5	1	—	2	2
9	8	3	4	2	6	—	4	5	1	5	2	2

No. 1 Set  
Builds

# WENEBRIK

BRITISH MADE

All Models  
from 1 to 30

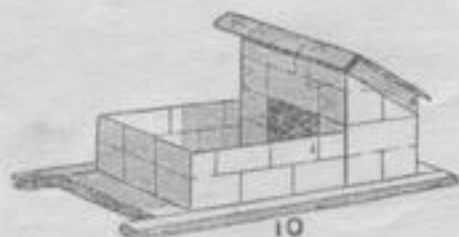

10  
Model No. 10



11  
Model No. 11

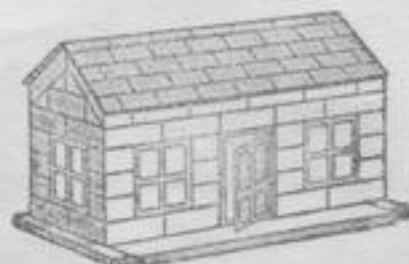

Model No. 12

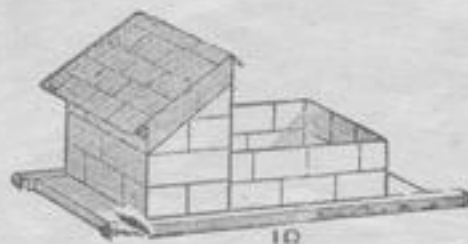

10  
Model No. 10



11  
Model No. 11



Model No. 12

Parts required	1	2	3	8	9	10	13	14	15	16	17	Bases.		
												A	B	C
<b>For Model No. 10</b>	9	—	8	4	26	8	2	3	1	—	—	2	2	—
<b>11</b>	28	22	26	16	44	8	4	5	1	10	2	—	2	2
<b>12</b>	22	14	16	16	56	8	4	7	1	6	2	—	2	2

No. 1 Set  
Builds

# WENEBRIK

BRITISH MADE

All Models  
from 1 to 30



Model No. 13



Model No. 13



Model No. 14



Model No. 14



Model No. 15

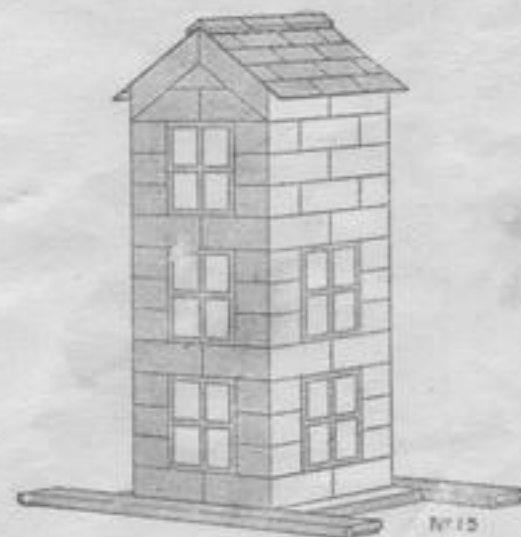

Model No. 15

Parts required	1	2	3	8	9	10	13	14	15	16	17	Bases.		
												A	B	C
<b>For Model No. 13</b>	14	14	22	4	28	8	4	3	1	6	1	2	2	—
	14	20	16	16	10	44	8	4	5	1	7	1	—	2
	15	20	20	30	10	20	8	4	2	1	9	1	—	2

No. 1 Set  
Builds



All Models  
from 1 to 30



Model No. 16

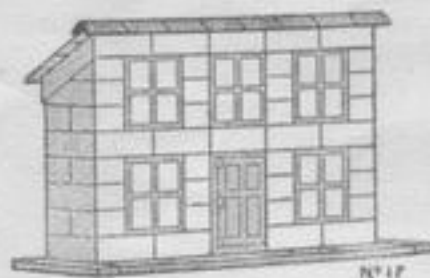

Model No. 17

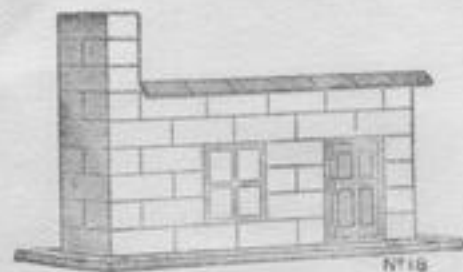

Model No. 18

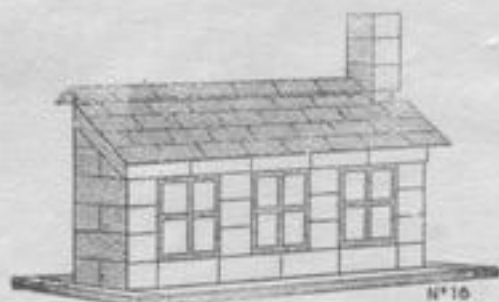

Model No. 16

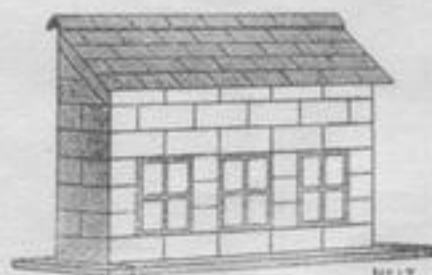

Model No. 17



Model No. 18

Parts required	1	2	3	8	9	10	13	14	15	16	17	Bases.	
												B	C
<b>For Model No. 16</b>	21	10	16	22	29	8	2	6	1	5	1	2	2
<b>17</b>	26	15	14	24	30	4	2	7	1	8	1	2	2
<b>18</b>	25	8	16	22	26	4	1	6	1	3	1	2	2

No. 1 Set  
Builds

# WENEBRIK

BRITISH MADE

All Models  
from 1 to 30



Model No. 19



Model No. 20



Model No. 21



Model No. 19

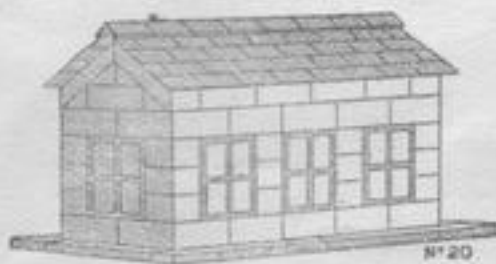

Model No. 20



Model No. 21

Parts required	1	2	3	8	9	10	13	14	15	16	17	Bases.		
												A	B	C
<b>For Model No. 19</b>	25	9	13	10	36	8	4	4	1	4	1	—	2	2
<b>20</b>	24	14	16	14	60	8	4	7	1	7	1	2	—	2
<b>21</b>	24	14	16	10	56	16	8	3	1	7	1	—	2	2

No. 1 Set  
Builds

# WENEBRIK

BRITISH MADE

All Models  
from 1 to 30



Model No. 22



Model No. 24



Model No. 23



Model No. 22



Model No. 24

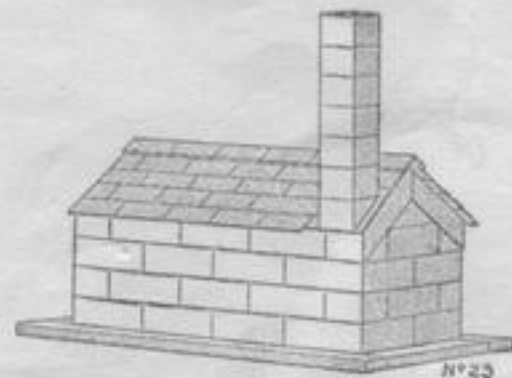

Model No. 23

Parts required	1	2	3	8	9	10	13	14	15	16	17	Bases.	
												B	C
<b>For Model No. 22</b>	24	18	18	8	56	16	8	3	1	8	1	2	2
<b>23</b>	23	5	21	10	41	8	4	5	1	2	1	2	2
<b>24</b>	19	12	14	8	44	8	6	5	1	4	—	2	2

No. 1 Set  
Builds

# WENEBRIK

BRITISH MADE

All Models  
from 1 to 30



Model No. 26



Model No. 25



Model No. 27



Model No. 26



Model No. 25



Model No. 27

Parts required	1	2	3	8	9	10	13	14	15	16	17	Bases.		
												A	B	C
<b>For Model No. 25</b>	26	8	4	24	60	8	8	7	1	6	—	2	—	2
26	25	14	14	6	52	8	4	6	1	5	1	—	2	2
27	27	17	26	6	28	8	4	3	1	7	1	2	2	2

No. 1 Set  
Builds

# WENEBRIK

BRITISH MADE

All Models  
from 1 to 30



Model No. 29



Model No. 28



Model No. 30



Model No. 28



Model No. 30



Model No. 29

Parts required	1	2	3	8	9	10	13	14	15	16	17	A	Bases.		
													B	C	
<b>For Model No. 28</b>	26	12	16	6	52	8	4	6	1	5	1	2	2	2	
<b>29</b>	18	22	28	18	28	8	4	3	1	10	1	2	2	2	
<b>30</b>	22	16	14	9	44	8	4	5	1	5	1	2	2	2	



# WENEBRIK

BRITISH MADE



Model No. 31



Model No. 32

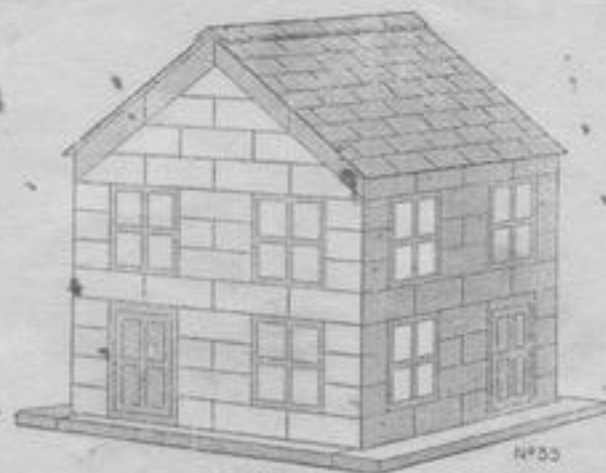

Model No. 33



Model No. 31



Model No. 32

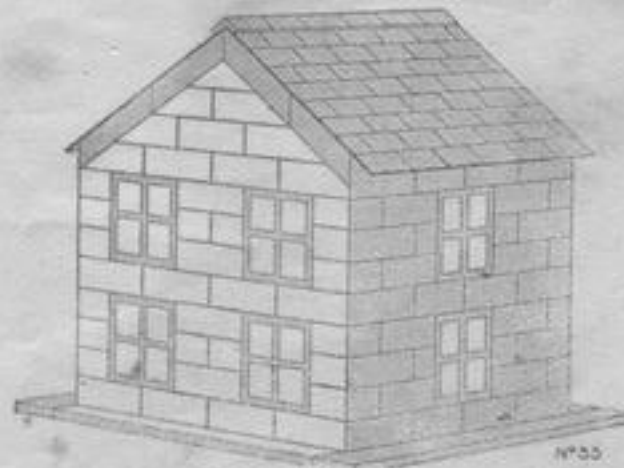

Model No. 33

Parts required	1	2	3	8	9	10	13	14	15	16	17	Bases.			
												A	B	C	D
<b>For Model No. 31</b>	44	28	16	34	72	16	8	4	1	12	2	2	2	1	2
<b>32</b>	46	28	28	24	44	8	4	5	1	12	2	—	2	2	—
<b>33</b>	50	28	20	28	88	16	8	5	1	12	2	—	—	2	2

No. 2 Set  
Builds

# WENEBRIK

BRITISH MADE

All Models  
from 1 to 40

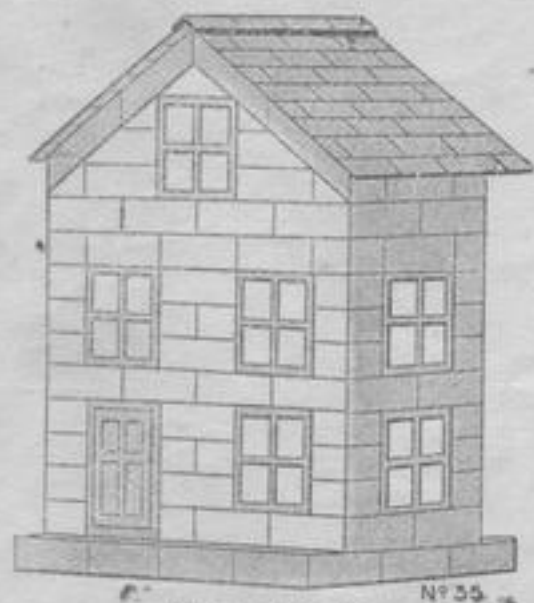

Model No. 35



Model No. 34



Model No. 35

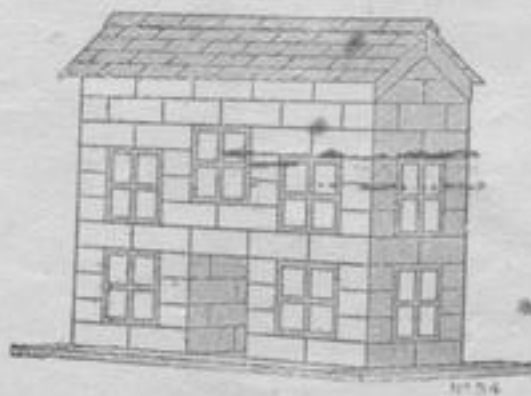

Model No. 34

Parts required	1	2	3	8	9	10	13	14	15	16	17	Bases.		
												B	C	D
For Model No. 34	46	30	35	18	60	8	4	7	1	12	2	2	—	2
35	42	33	31	18	56	16	8	3	1	12	2	—	—	2

No. 2 Set  
Builds

# WENEBRIK

BRITISH MADE

All Models  
from 1 to 40



N°36

Model No. 36



N°36

Model No. 36



N°37

Model No. 37



N°37

Model No. 37

Parts required	1	2	3	8	9	10	13	14	15	16	17	Bases.			
												A	B	C	D
For Model No. 36	46	28	35	18	40	16	8	4	2	12	2	—	2	2	—
37	49	12	12	18	66	12	6	5	1	4	2	2	2	2	2

No. 2 Set  
Builds

# WENEBRIK

BRITISH MADE

All Models  
from 1 to 40



Model No. 38



Model No. 40



Model No. 39



Model No. 38



Model No. 40



Model No. 39

Parts required	1	2	3	8	9	10	13	14	15	16	17	Bases.			
												A	B	C	D
For Model No. 38	46	23	25	30	36	8	4	4	1	10	2	2	2	1	2
39	45	26	32	24	36	8	4	4	1	12	2	—	2	2	2
40	45	19	20	16	60	8	4	7	1	6	2	2	2	2	1

No. 3 Set  
Builds

# WENEBRIK

BRITISH MADE

All Models  
from 1 to 50



Model No. 41



Model No. 42



Model No. 42



Model No. 41

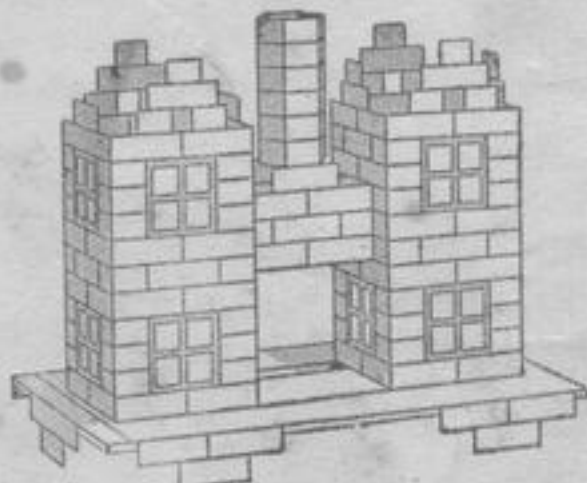

Model No. 43

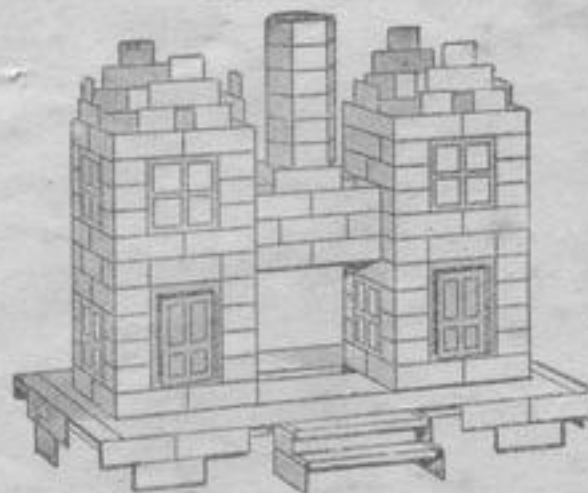

Model No. 43

Parts required	1	2	3	4	5	8	9	10	13	14	15	16	17	Bases			
														A	B	C	D
For Model No. 41	28	22	12	—	—	16	120	16	8	7	1	8	2	2	2	2	—
42	23	28	28	—	—	24	56	8	4	7	1	14	2	2	2	2	—
43	50	38	41	4	18	44	—	—	—	—	—	12	2	—	—	2	2

# WENEBRIK

BRITISH MADE

All Models from 1 to 50



Model No. 45



Model No. 44

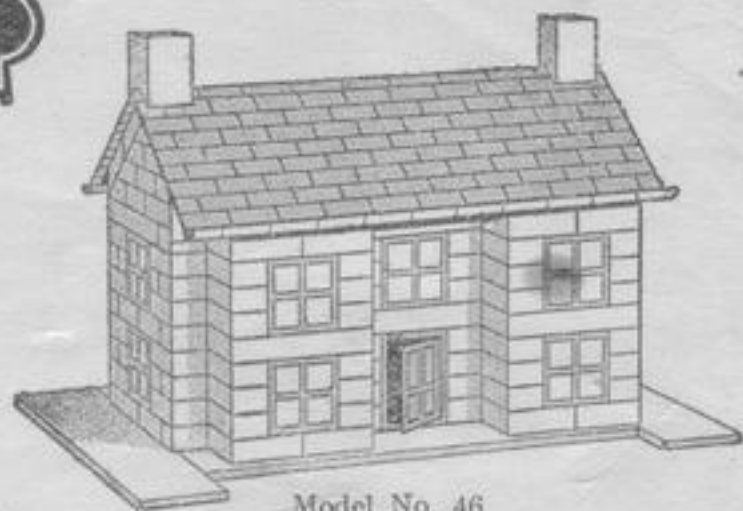

Model No. 46

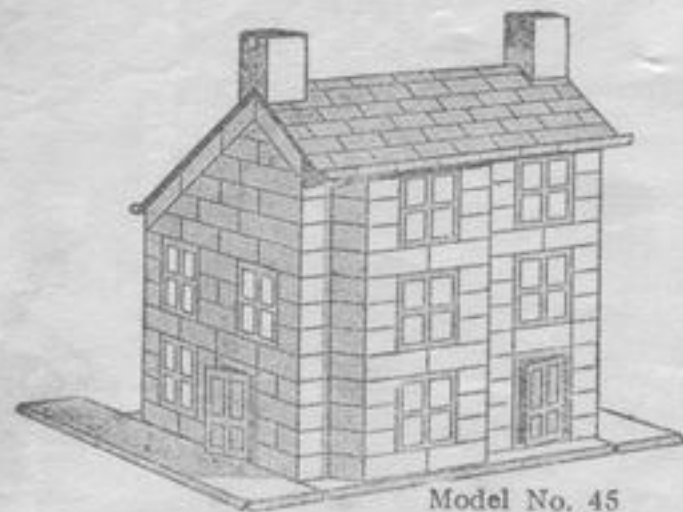

Model No. 45

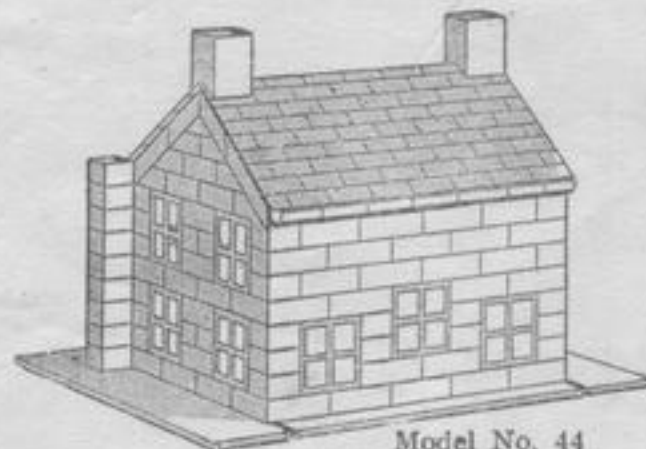

Model No. 44



Model No. 46

Parts required	1	2	3	4	5	6	7	8	9	10	11	12	13	14	15	16	17	Bases.				
																		A	B	C	D	G
<b>For Model No. 44</b>	69	24	34	16	—	—	4	32	112	16	14	4	8	7	1	13	2	—	—	—	2	2
45	58	28	22	—	12	11	—	44	120	17	14	4	8	7	1	14	3	—	—	—	2	2
46	58	44	36	15	8	8	—	48	180	18	20	4	10	10	1	14	3	2	2	2	2	2

No. 3 Set  
Builds

# WENEBRIK

BRITISH MADE

All Models  
from 1 to 50



Model No. 47



Model No. 48

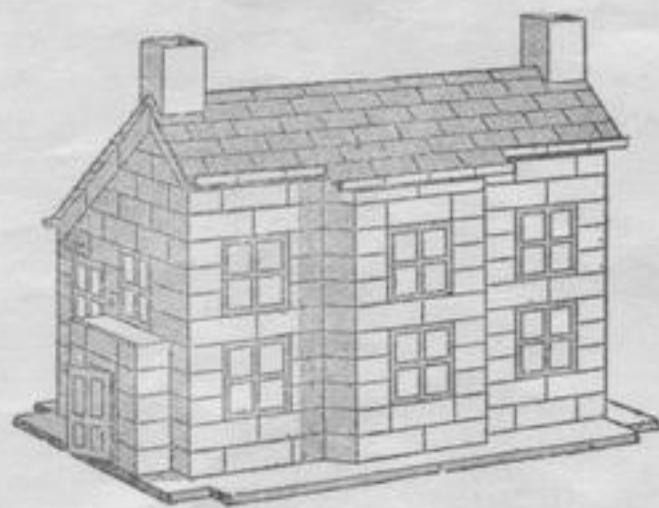

Model No. 47



Model No. 48

Bases.

Parts required	1	2	3	4	5	6	7	8	9	10	11	13	14	15	16	17	19	A	B	C	G
<b>For Model No. 47</b>	67	31	24	4	10	10	2	47	156	16	20	8	10	1	14	3	2	2	1	—	—
48	70	26	18	—	8	6	—	49	132	12	20	8	10	1	11	3	2	—	—	2	2

No. 3 Set  
Builds

# WENEBRIK

BRITISH MADE

All Models  
from 1 to 50

Model  
No. 49



Model  
No. 50

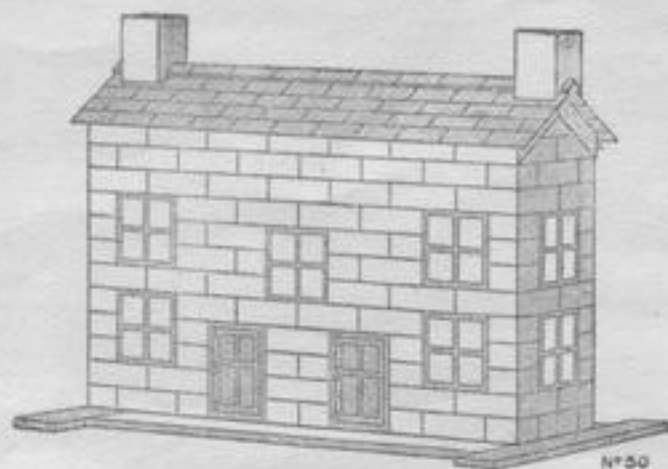

Model  
No. 49



Model  
No. 50

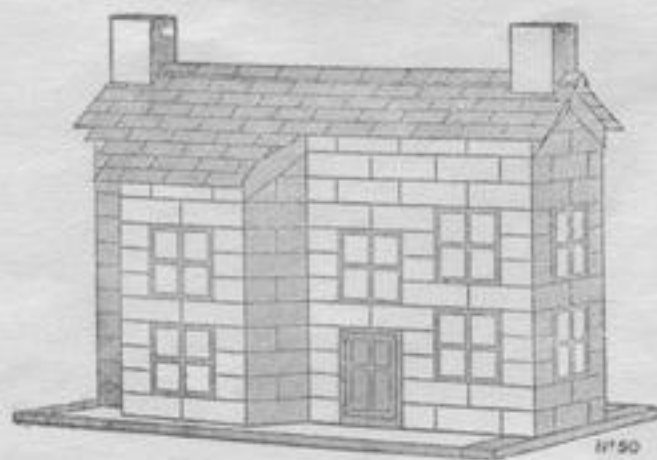

Parts required

	1	2	3	4	5	6	7	8	9	10	13	14	15	16	17	19	Bases.	
																	C	G
For Model No. 49	35	33	24	9	—	—	—	39	—	—	10	10	1	13	2	2	2	2
50	64	41	22	16	10	10	2	44	99	10	6	10	1	14	3	2	2	2



# WENEBRIK

BRITISH MADE

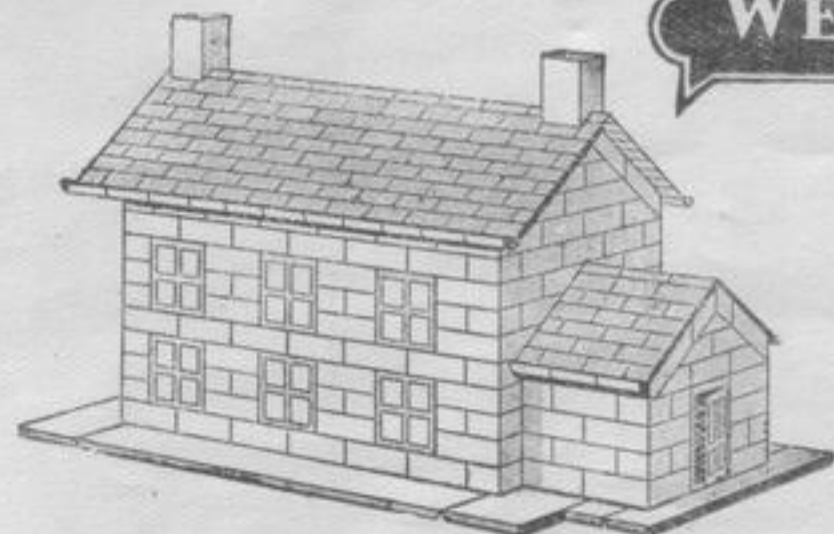

Model No. 51



\*Model No. 51

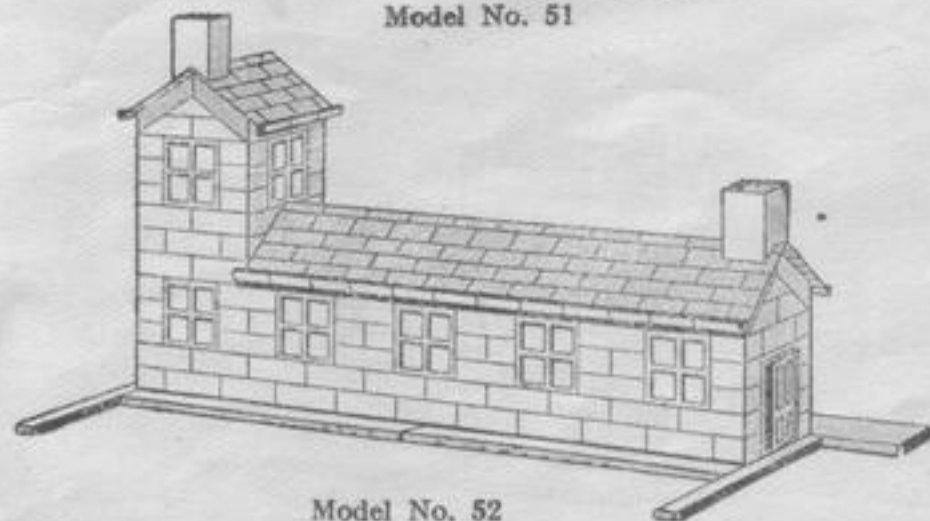

Model No. 52



Model No. 52

Parts required	1	2	3	4	5	6	7	8	9	10	11	13	14	15	16	17	19	Bases.				
																		A	B	C	F	G
<b>For Model No. 51</b>	106	39	20	4	12	8	—	46	206	28	32	12	13	2	14	1	2	—	—	2	1	4
<b>52</b>	74	29	32	—	—	—	—	21	110	16	30	6	14	2	18	3	2	2	1	2	—	2

# WENEBRIK

BRITISH MADE

All Models from 1 to 60

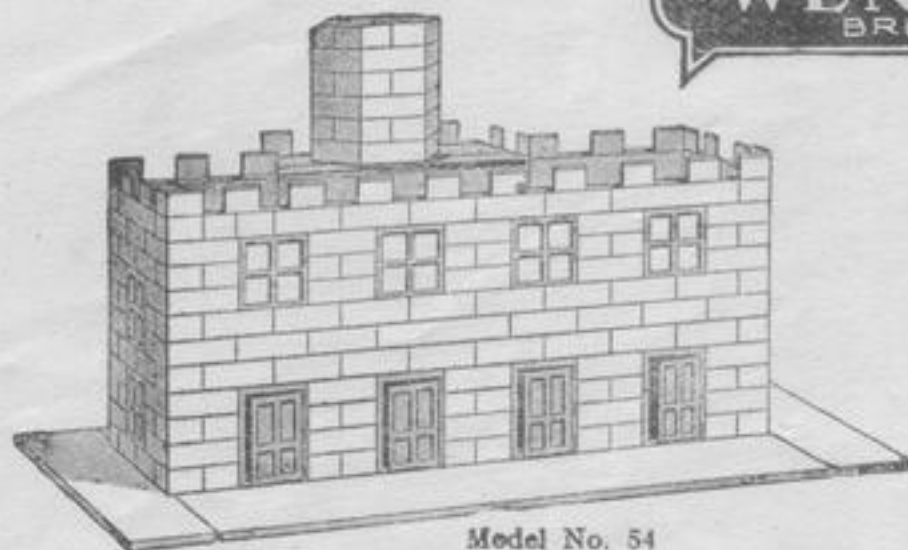

Model No. 54

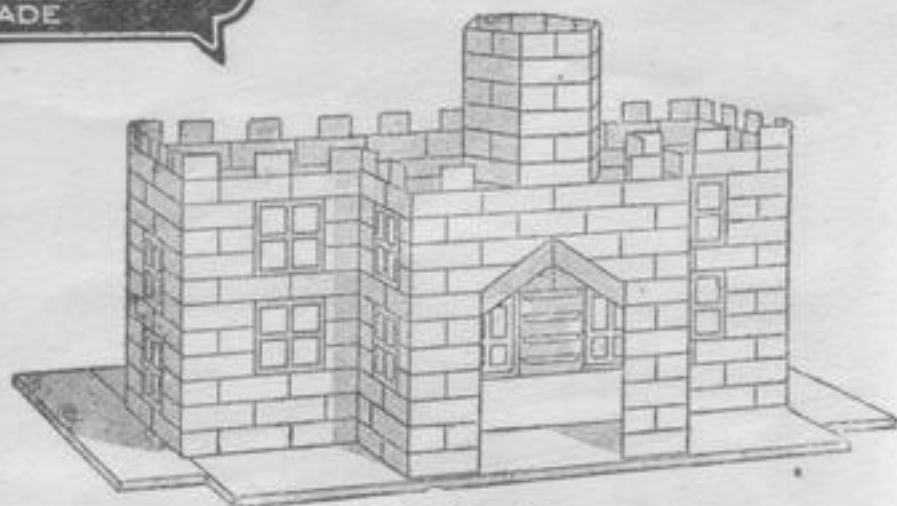

Model No. 54

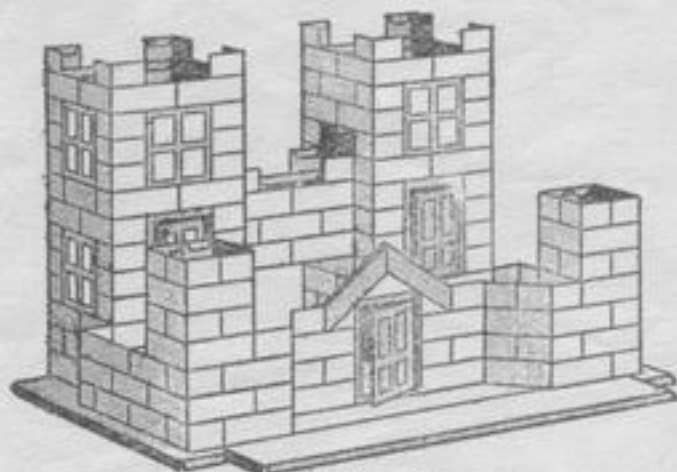

Model No. 53

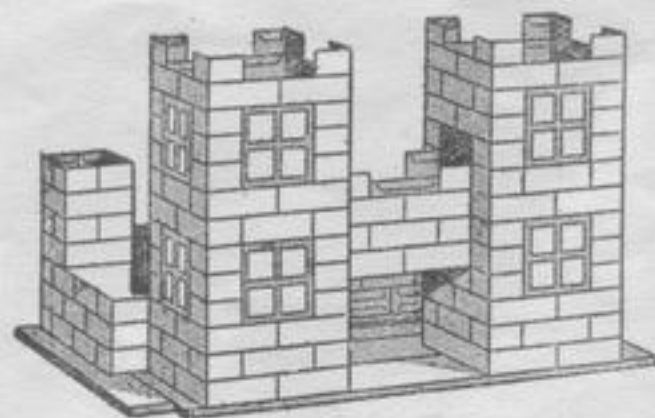

Model No. 53

Parts required	1	2	3	4	5	6	7	8	13	16	17	H	Bases, C	G
<b>For Model No. 53</b>	86	53	68	8	4	4	2	42	2	10	3	—	2	4
<b>54</b>	111	48	38	16	18	—	—	60	2	16	4	2	—	2

No. 4 Set  
Builds

# WENEBRIK

BRITISH MADE

All Models  
from 1 to 60

27

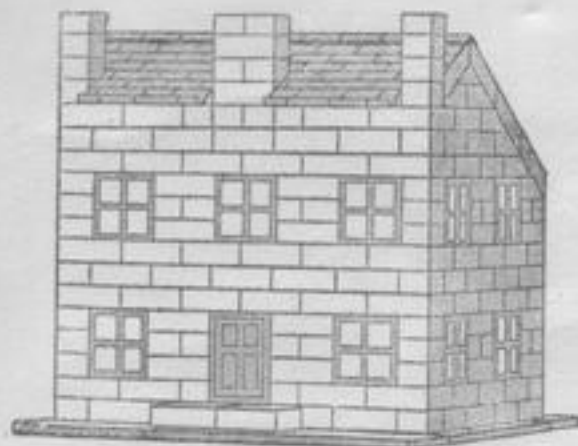

N° 56

Model No. 56

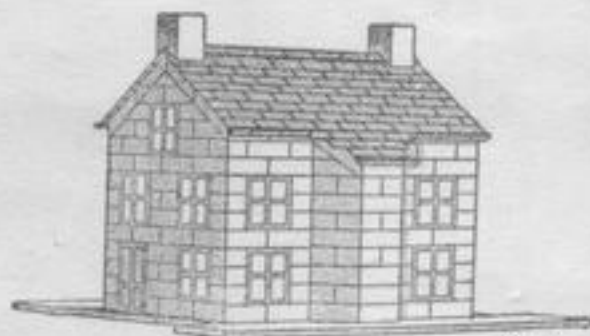

N° 55

Model No. 55

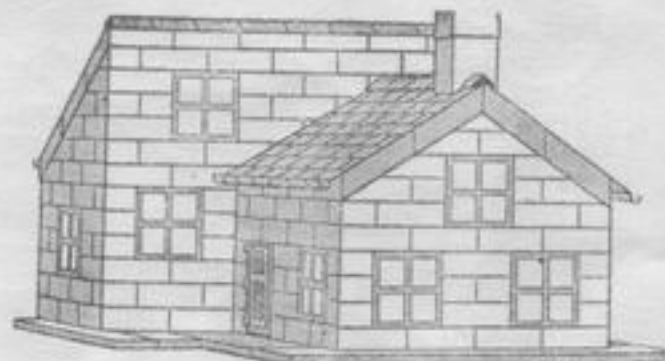

Model No. 57



N° 56

Model No. 56

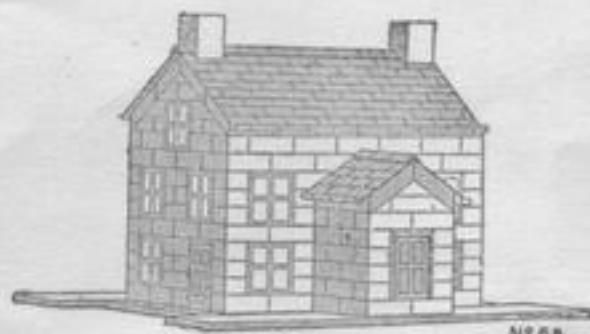

N° 55

Model No. 55



N° 57

Model No. 57

Parts required	1	2	3	4	5	6	8	9	10	11	12	13	14	15	16	17	19	Bases.					
																		A	B	H	C	D	G
<b>For Model No. 55</b>	87	47	32	6	8	10	35	165	24	17	10	12	11	2	16	3	2	—	1	2	—	2	—
<b>56</b>	129	43	55	—	—	—	41	143	20	12	6	8	8	1	16	3	—	2	2	—	—	—	2
<b>57</b>	111	41	21	3	—	—	36	194	28	18	6	10	13	2	11	3	1	—	—	—	2	1	4

No. 4 Set  
Builds

# WENEBRIK

BRITISH MADE

All Models  
from 1 to 60

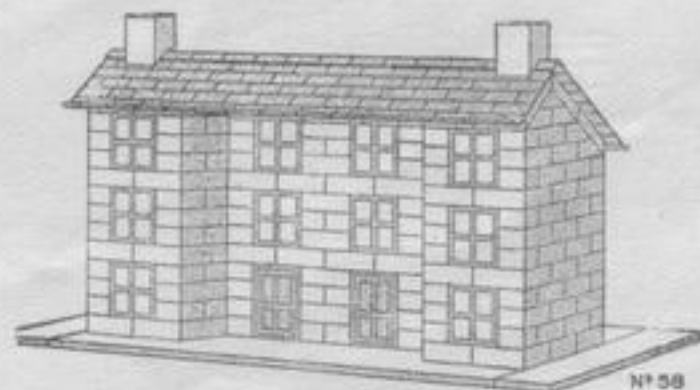

Model No. 58

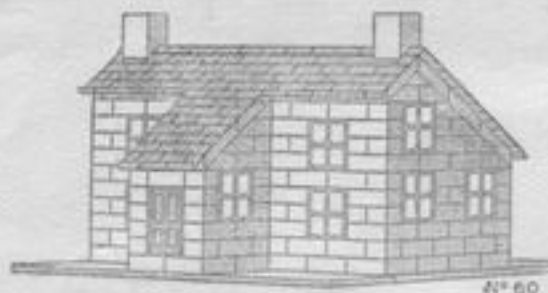

Model No. 60



Model No. 59



Model No. 58



Model No. 60

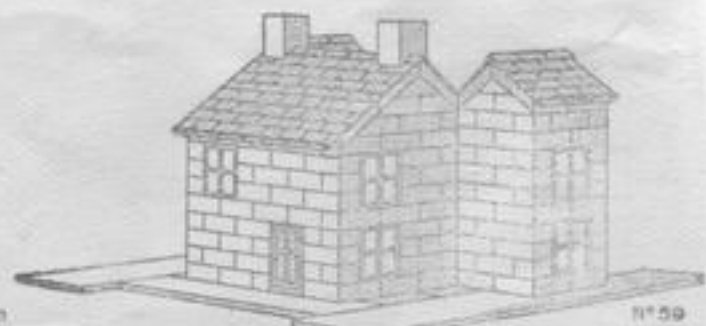

Model No. 59

Parts required	1	2	3	4	5	6	8	9	10	11	12	13	14	15	16	17	19	Bases.		
																		H	D	G
<b>For Model No. 58</b>	128	48	22	—	12	14	54	162	12	26	4	8	13	1	16	4	2	2	—	2
<b>59</b>	116	55	40	17	—	—	44	142	31	23	3	14	10	3	15	3	2	2	—	4
<b>60</b>	105	39	25	10	—	—	34	205	24	22	4	12	11	1	14	3	2	2	2	—

No. 5 Set  
Builds

# WENEBRIK

BRITISH MADE

All Models  
from 1 to 70

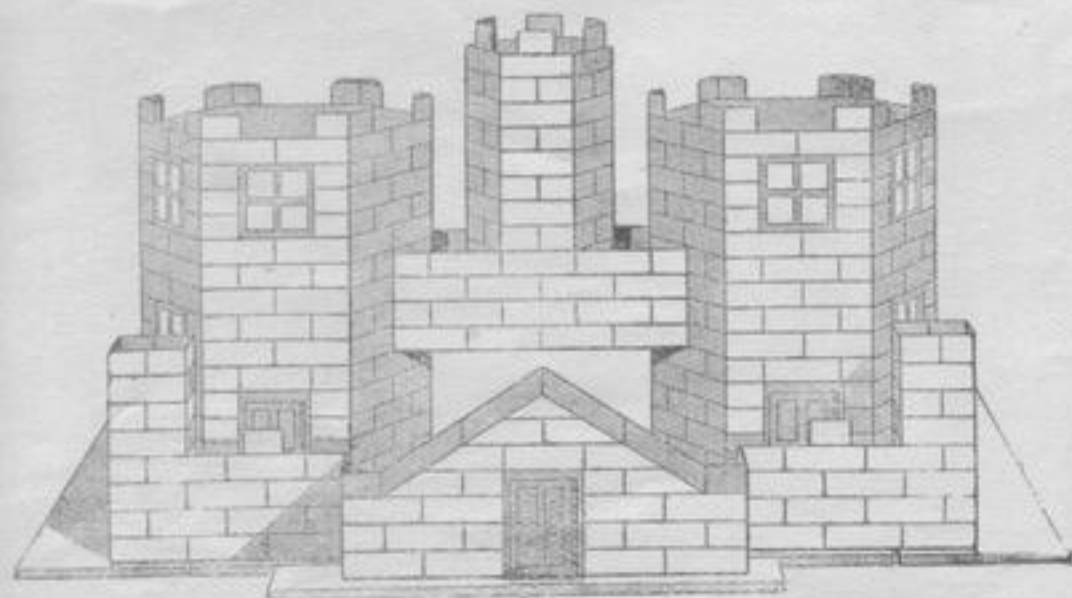

Model No. 61

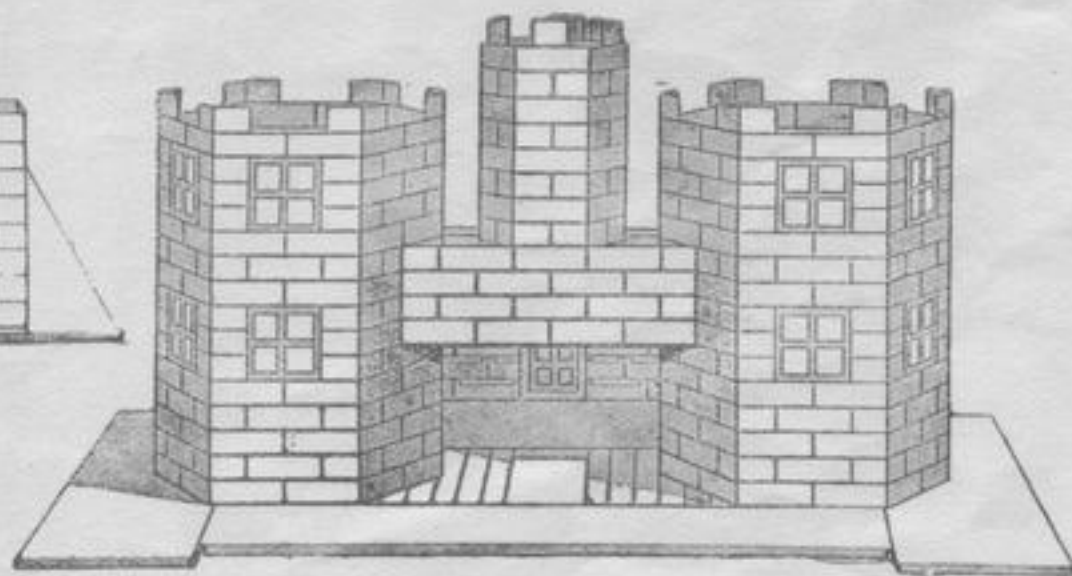

Model No. 61

Parts required	1	2	3	4	5	6	8	13	16	17	H	Bases.	
												E	G
<b>For Model No. 61</b>	245	81	24	4	126	8	28	4	14	3	4	12	1

No. 5 Set  
Builds

# WENEBRIK

BRITISH MADE

All Models  
from 1 to 70

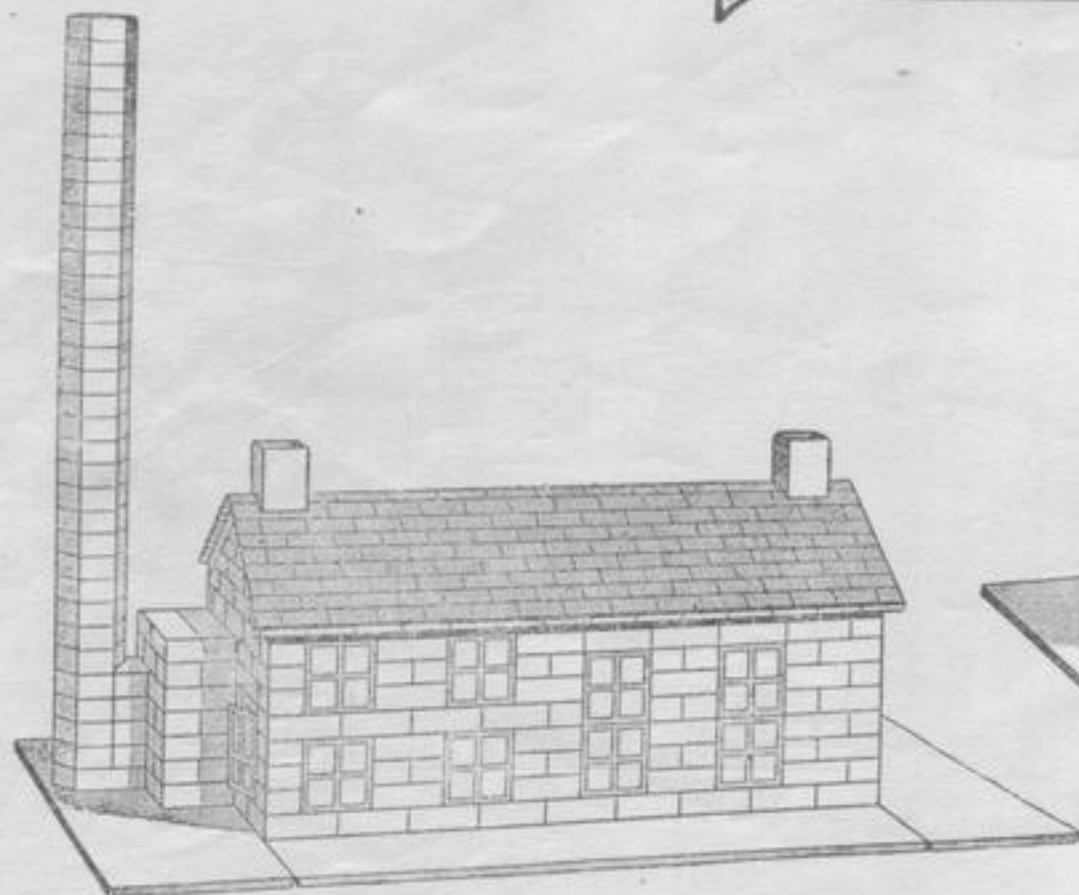

Model No. 62



Model No. 62

Parts required	1	2	3	4	5	8	9	10	11	13	14	15	16	17	19	Bases.	
																B	H
<b>For Model No. 62</b>	113	34	18	5	126	54	108	16	28	8	13	1	18	3	2	2	4

No. 5 Set  
Builds

# WENEBRIK

BRITISH MADE

All Models  
from 1 to 70



Model No. 63

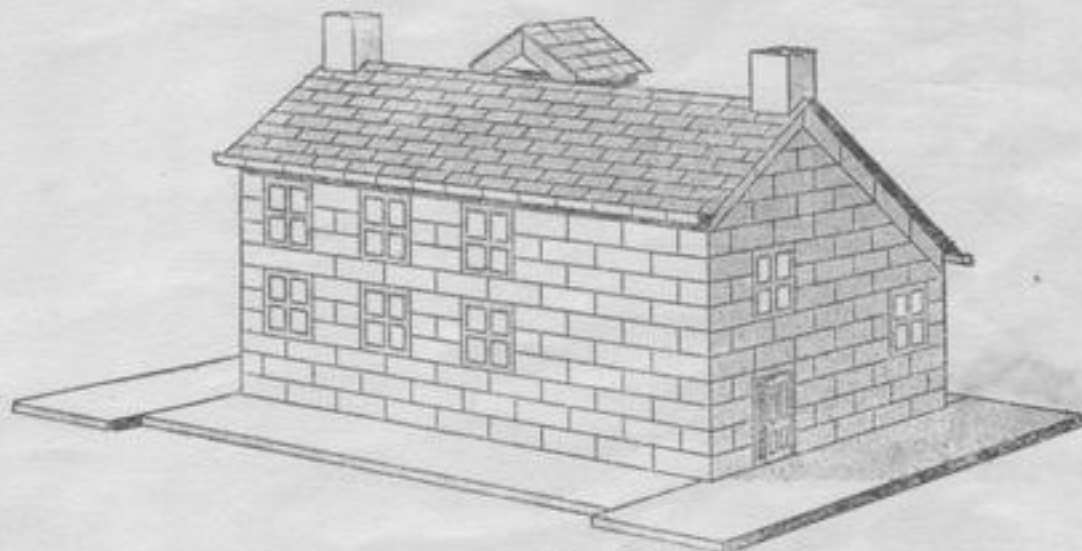

Model No. 63

Parts required	1	2	3	4	8	9	10	11	13	14	15	16	17	19	Bases.		
															B	H	D
<b>For Model No. 63</b>	186	43	28	5	48	240	40	26	16	15	2	16	3	2	2	4	2

No. 5 Set  
Builds

**WENEBRIK**  
BRITISH MADE

All Models  
from 1 to 70

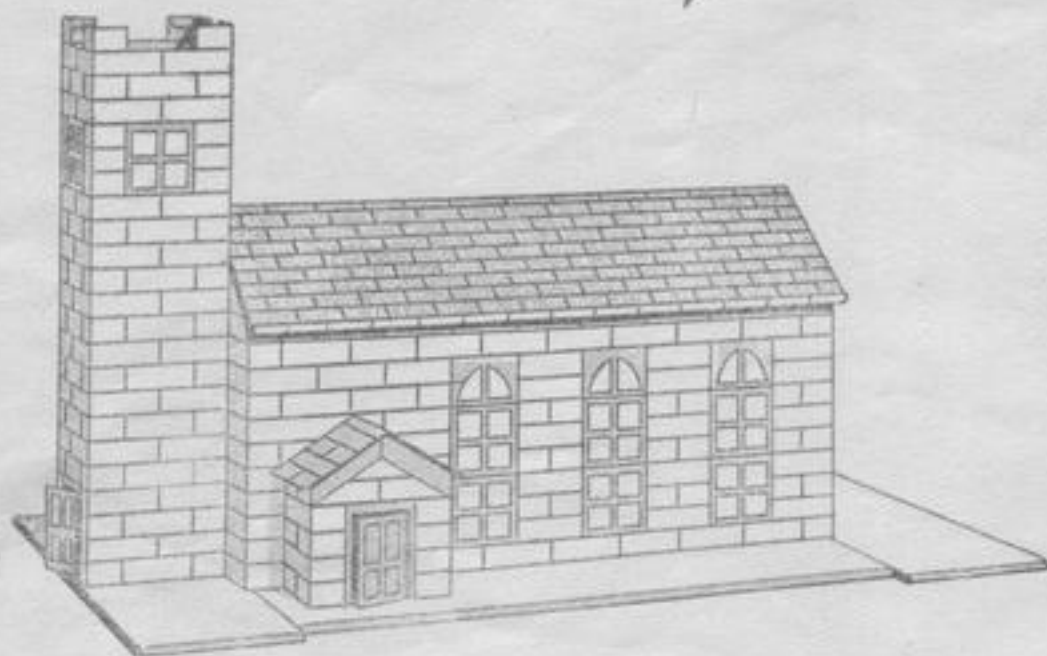

Model No. 64

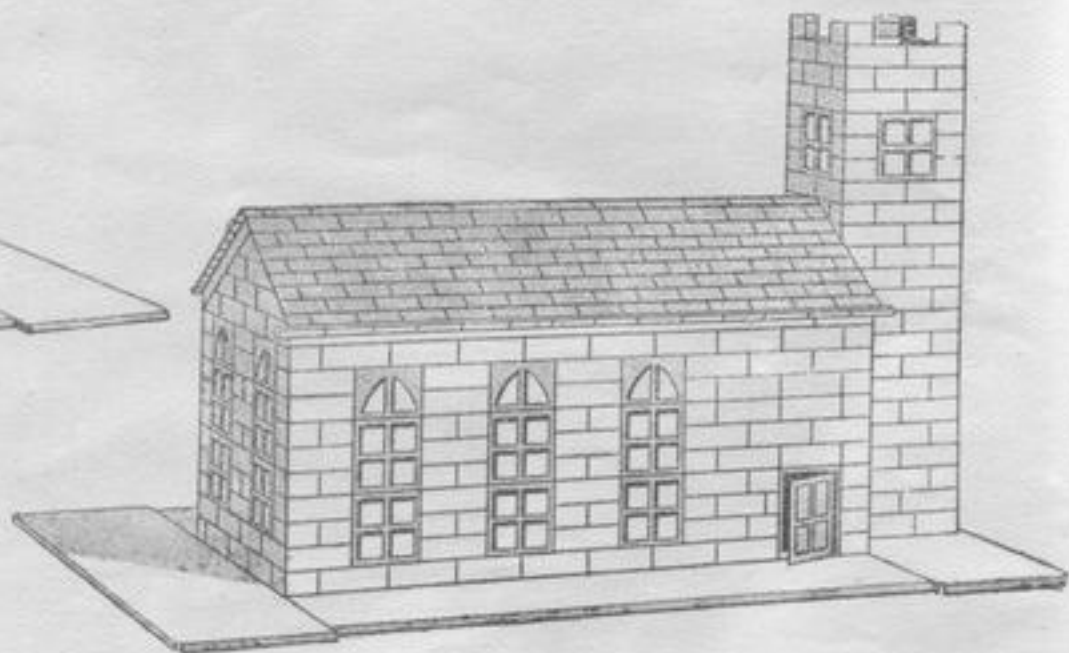

Model No. 64

Parts required	1	2	3	4	7	8	9	10	11	13	14	15	16	17	18	19	Bases.	
																	B	H
<b>For Model No. 64</b>	208	32	58	14	4	84	220	24	28	10	14	2	20	3	6	2	1	4



No. 5 Set  
Builds

# WENEBRIK

BRITISH MADE

All Models  
from 1 to 70

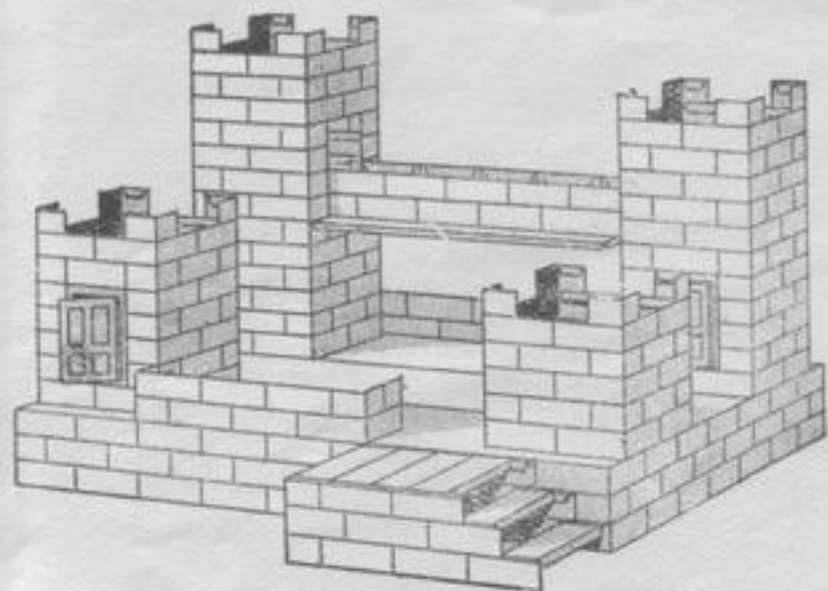

Model No. 65

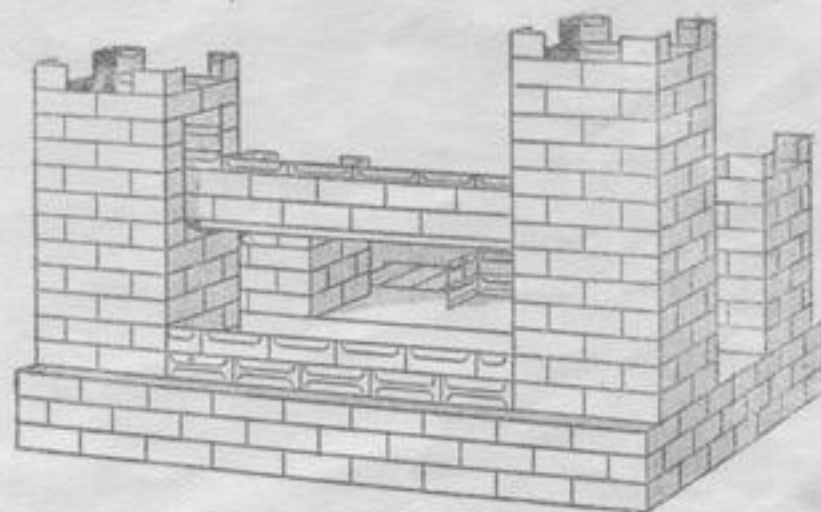

Model No. 65

Parts required	1	2	3	4	8	17	B	Bases. H	C
<b>For Model No. 65</b>	260	75	84	7	14	2	6	3	2

No. 5 Set  
Builds

# WENEBRIK

BRITISH MADE

All Models  
from 1 to 70

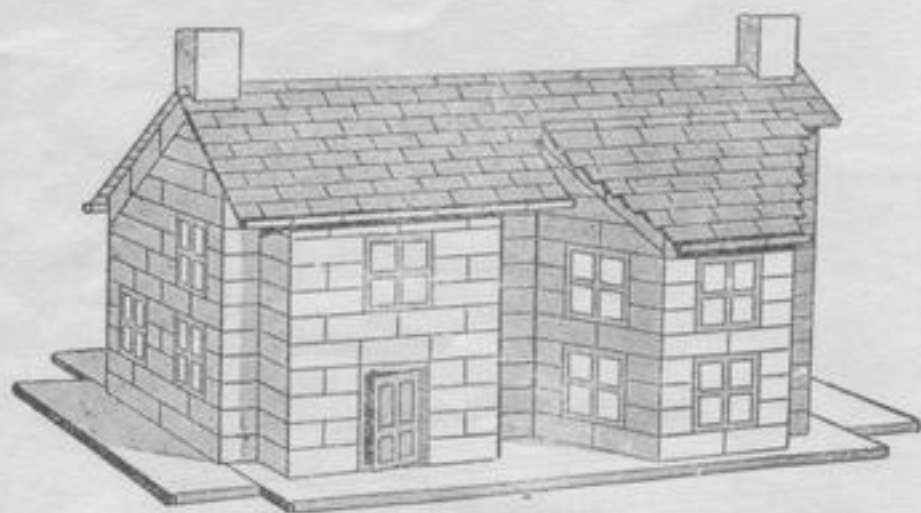

Model No. 66

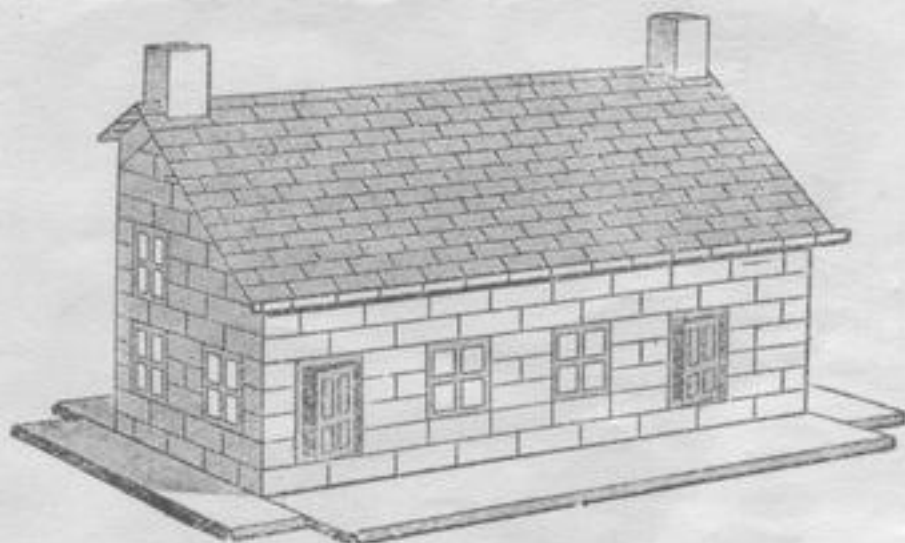

Model No. 66

Parts required	1	2	3	4	5	6	8	9	10	11	13	14	15	16	17	19	Bases.	
																	H	G
<b>For Model No. 66</b>	112	45	28	10	8	12	44	280	23	25	14	19	1	15	3	2	2	2

No. 5 Set  
Builds

# WENEBRIK

BRITISH MADE

All Models  
from 1 to 70

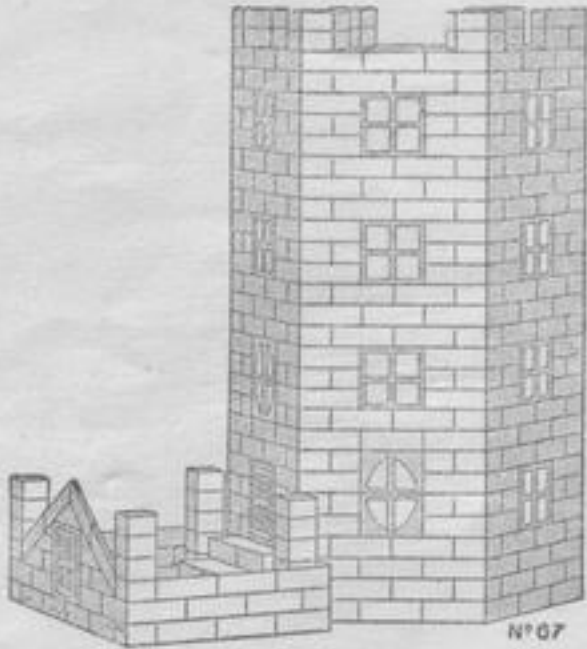

Model No. 67

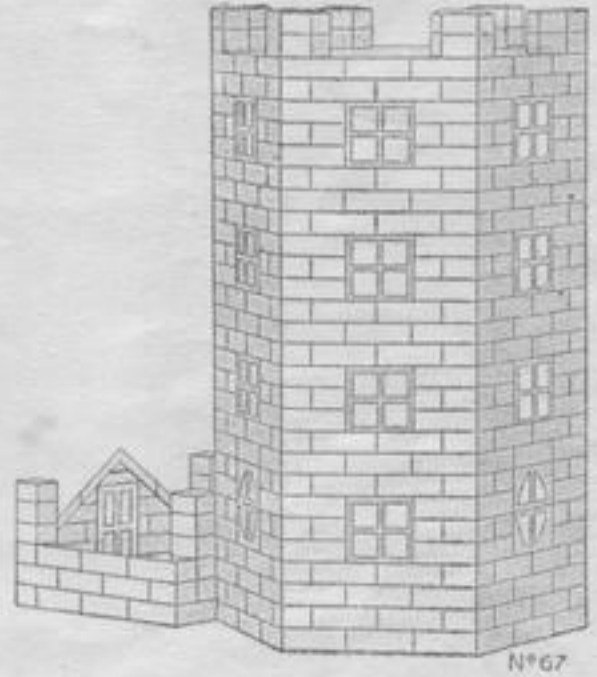

Model No. 67

Parts required	1	2	3	4	5	7	8	13	16	17	20	Base B
<b>For Model No. 67</b>	260	78	38	4	114	2	64	4	20	2	8	3

No. 5 Set  
Builds

**WENEBRIK**  
BRITISH MADE

All Models  
from 1 to 70

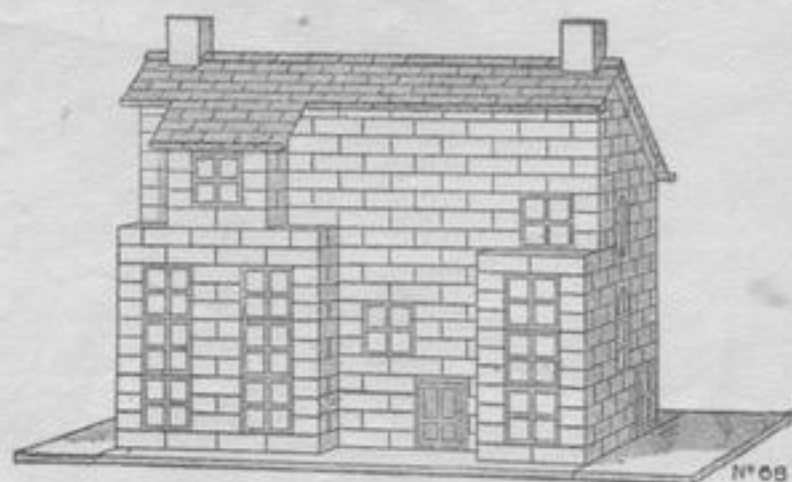

Model No. 68

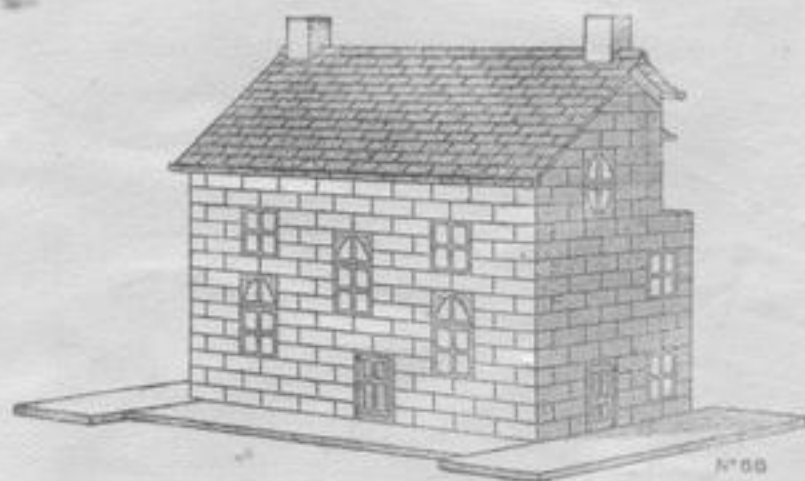

Model No. 68

Parts required	1	2	3	4	5	9	10	11	12	13	14	15	16	17	18	19	Bases.		
																	B	H	D
<b>For Model No. 68</b>	255	53	49	17	73	230	20	26	4	10	13	1	20	4	2	8	2	4	2

No. 5 Set  
Builds

# WENEBRIK

BRITISH MADE

All Models  
from 1 to 70

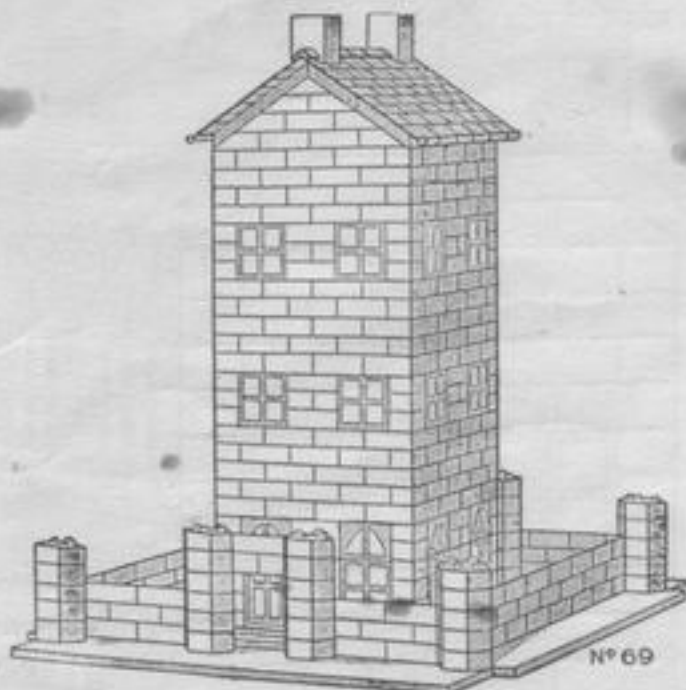

Model No. 69.

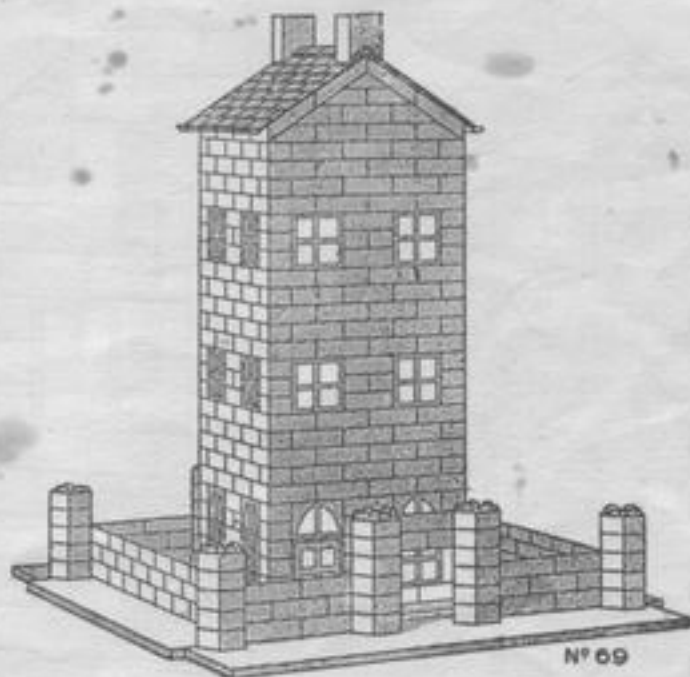

Model No. 69

Parts required	1	2	3	4	5	6	8	9	10	11	12	13	14	15	16	17	18	19	Bases.		
	H	C	D																		
<b>For Model No. 69</b>	258	74	68	4	116	12	56	104	16	12	4	8	6	1	20	4	8	2	4	2	2

No. 5 Set  
Builds

# WENEBRIK

BRITISH MADE

All Models  
from 1 to 70

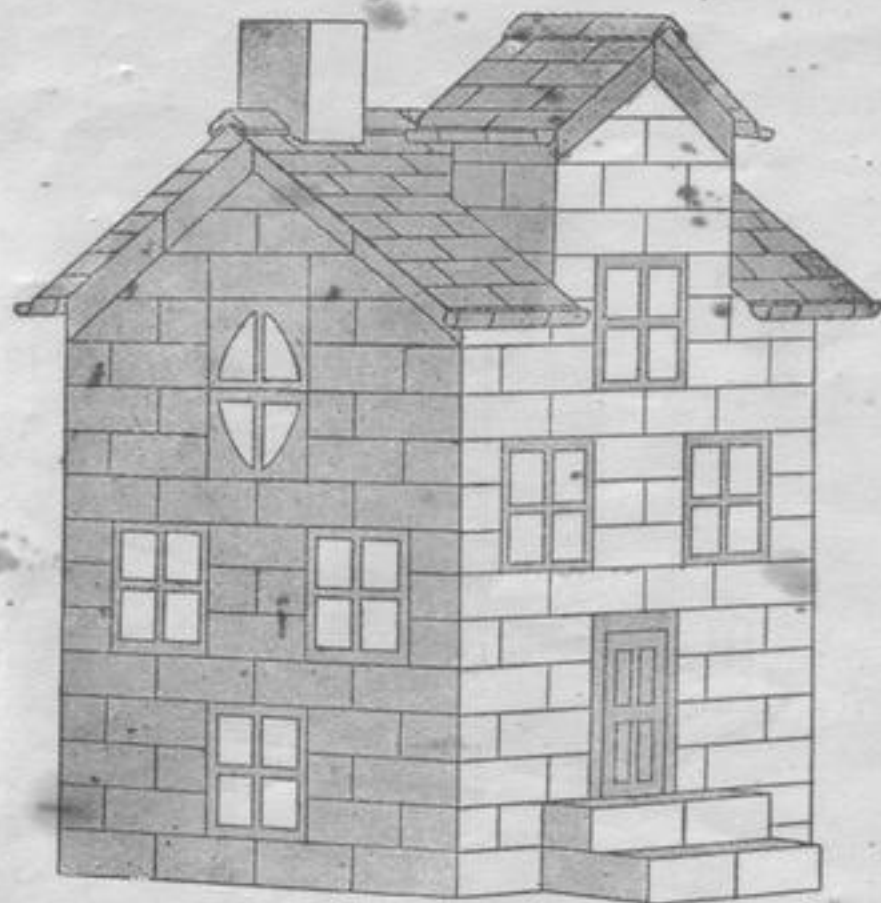

N°70

Model No. 70

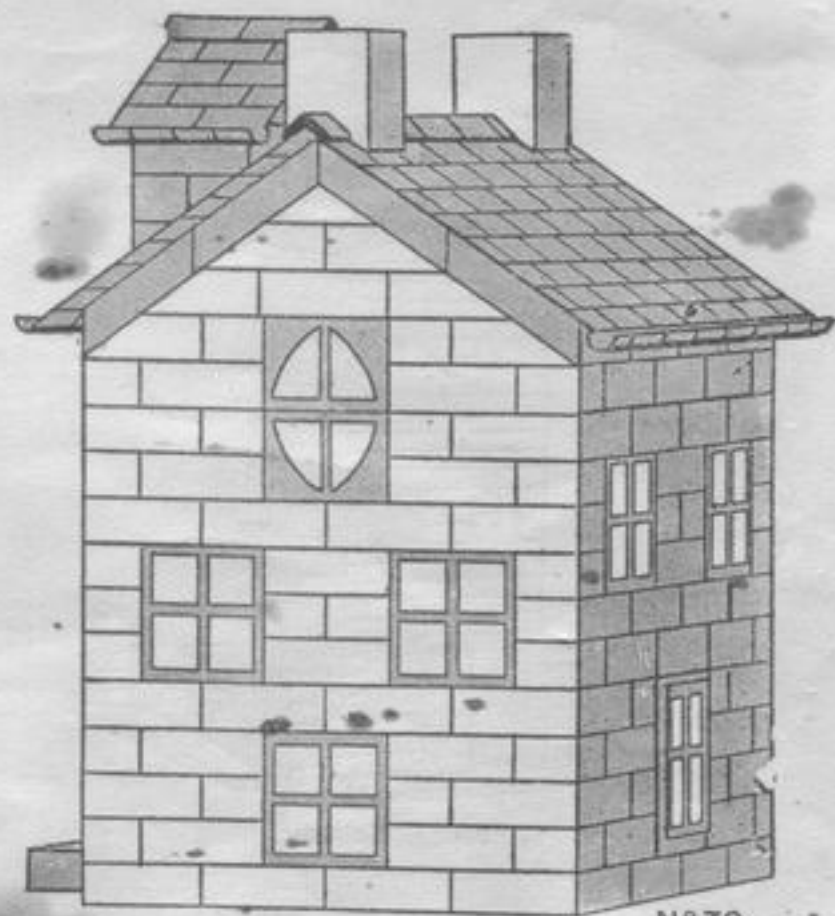

N°70

Model No. 70

Parts required	1	2	3	4	8	9	10	11	12	13	14	15	16	17	18	19	Bases.		
																	B	D	
<b>For Model No. 70</b>	99	46	30	2	38	99	26	10	10	12	7	2	11	2	4	2	2	2	2

# CONTENTS OF WENEBRIK SETS.

NAME OF PARTS.	No.	SETS						ACCESSORY SETS				
		0	1	2	3	4	5	0a	1a	2a	3a	4a
Brick .. .. .	1	9	28	50	70	129	260	19	22	20	59	131
Foundation or Binder Brick .. .. .	2	10	28	34	44	60	84	18	6	10	16	24
Corner Brick 90° .. .. .	3	14	30	36	41	68	85	16	6	5	27	17
"    Inverted .. .. .	4	—	—	—	16	20	20	—	—	16	4	—
"    Hexagon .. .. .	5	—	—	—	18	20	126	—	—	18	2	106
"    Inverted .. .. .	6	—	—	—	11	20	20	—	—	11	9	—
Foundation Corner Brick .. .. .	7	—	—	—	4	8	8	—	—	4	4	—
Half Brick .. .. .	8	10	24	34	49	60	84	14	10	15	11	24
Slate .. .. .	9	40	60	88	180	206	285	20	28	92	26	79
Half Slate .. .. .	10	8	16	16	18	32	40	8	—	2	14	8
Gutter .. .. .	11	—	—	—	20	32	40	—	—	20	12	8
Half Gutter .. .. .	12	—	—	—	4	10	10	—	—	4	6	—
Cornice .. .. .	13	4	8	10	10	16	18	4	2	—	6	2
Ridge Tile .. .. .	14	5	7	7	10	15	18	2	—	3	5	3
End Ridge Tile .. .. .	15	1	1	2	2	3	3	—	1	—	1	—
Window 1½ × 1½ .. .. .	16	5	10	12	14	16	20	5	2	2	2	4
Door and Frame .. .. .	17	1	2	3	3	4	4	1	1	—	1	—
Window 1½ × 1 .. .. .	18	—	—	—	—	—	8	—	—	—	—	8
Chimney, 4 pieces .. .. .	19	—	—	—	2	2	2	—	—	2	—	—
<b>BASES.</b>												
6½ × .. .. .	A.	2	2	2	2	2	2	—	—	—	—	—
2½ × .. .. .	B.	2	2	2	2	2	6	—	—	—	—	—
7½ × 1 .. .. .	C.	—	—	2	2	2	2	2	—	—	—	—
5½ × .. .. .	D.	—	—	2	2	2	2	—	2	—	—	—
5 × .. .. .	E.	—	—	—	—	—	12	—	—	—	—	12
4½ × .. .. .	F.	—	—	—	—	1	1	—	—	—	1	—
9½ × 1 .. .. .	G.	—	—	—	2	4	4	—	—	2	2	—
13½ × 3 .. .. .	H.	—	—	—	—	2	4	—	—	—	2	2
	—	111	220	300	526	736	1168	109	80	226	210	432
Price each		2/6	5/-	7/6	12/6	22/6	37/6	3/-	3/-	5/6	12/6	18/-

# WENEBRIK

*"The more than toy"*



A GROUP OF WENEBRIK MODELS.